

THIS DRAWING REMAINS THE PROPERTY OF MOSTRON ELEKTRONIK GMBH. WITHOUT OUR WRITTEN PERMISSION, THE DUPLICATION AND/OR EXPLOITATION IS PROHIBITED, ALSO FOR THIRD PARTIES. (OBSERVE THE GERMAN LAW OF 09.01.1907, §15 and §17 AGAINST UNFAIR COMPETITION §16). THIS DRAWING IS SUBJECT TO CHANGE WITHOUT PRIOR NOTICE.

A (1 : 1)

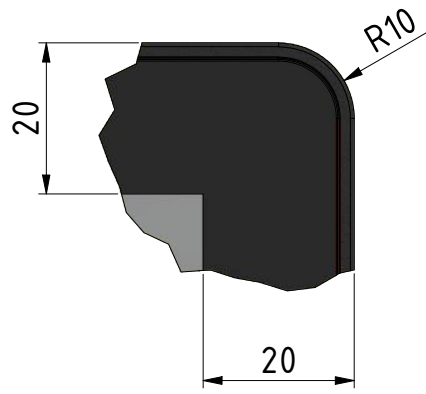

C (2 : 3)

ohne Kabelabdeckung

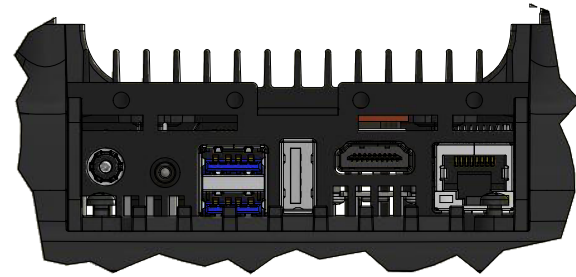

C

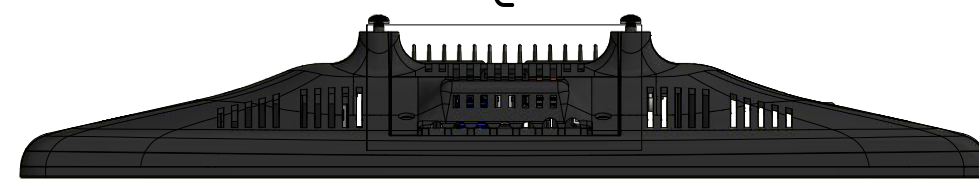

B (2 : 3)

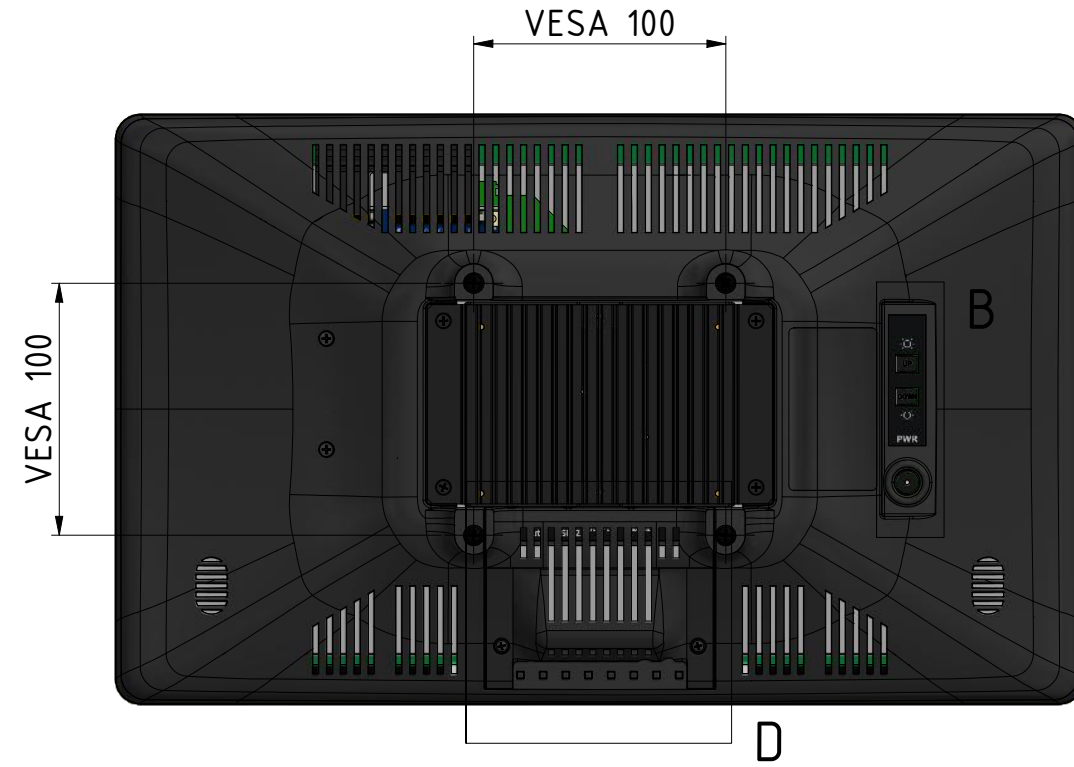
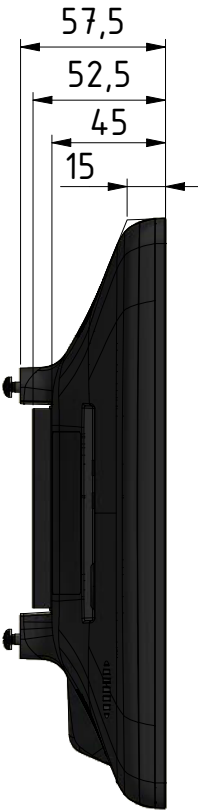

D (2 : 3)

ohne Kabelabdeckung

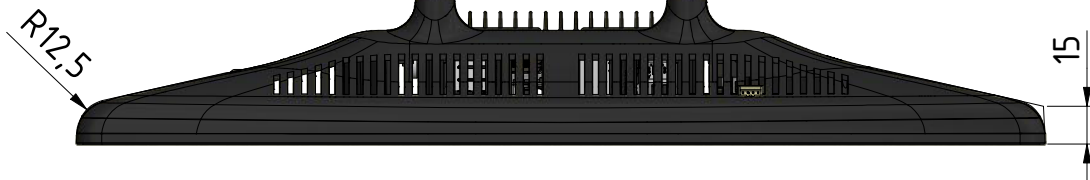
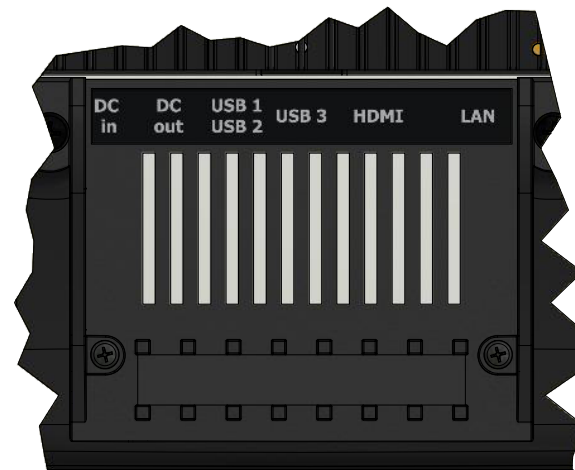

date	name	15,6 Zoll PPC mit MOSttron Siebdruck	
change			
Tol. -> DIN ISO2768-1 m	first angle		
scale: 1 : 1	ISO 2768-mK		
MOSTRON ELEKTRONIK		POS-15,6-PPC	1 of 1
			A3